

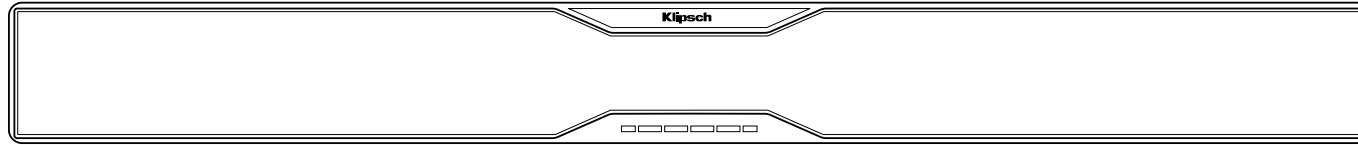

Klipsch[®]
REFERENCE
R-10B

CONTENTS

CONTENU • CONTENIDO • INHALT • CONTENUTO • CONTEÚDO • 目录



Soundbar

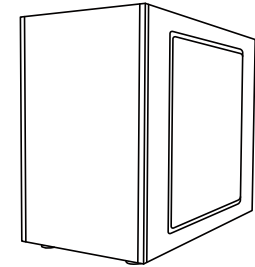

Subwoofer



Wall-Mount Template

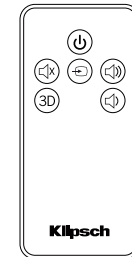

Remote

Soundbar	Subwoofer	Wall-Mount Template	Remote
Barre de son	Caisson de graves	Gabarit de montage mural	Télécommande
Barra de sonido	Subwoofer	Plantilla de montaje en la pared	Control remoto
Soundbar	Subwoofer	Wandbefestigungsschablone	Fernbedienung
SoundBar	Subwoofer	Dima per il fissaggio a parete	Telecomando
Barra sonora	Subwoofer	Modelo para instalação na parede	Control remoto
条形音箱	低音炮	挂壁模板	遥控器

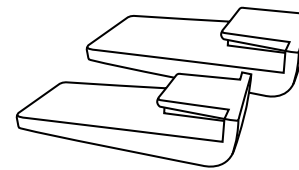
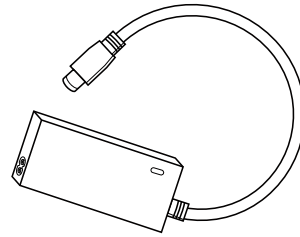
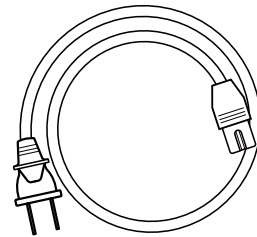
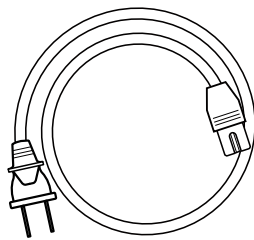

AC Adapter / Power Cord

Rubber Feet

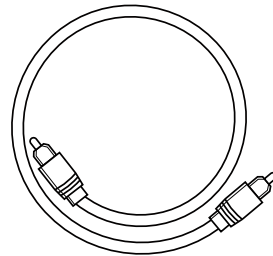

Digital Optical Cable

AC Adapter / Power Cord

Adaptateur CA / Cordon d'alimentation

Adaptador de CA y cordón de alimentación

Netzteil/Netzkabel

Cavo di alimentazione e adattatore di corrente

Cabo de alimentação / adaptador de CA

交流适配器/电源线

Rubber Feet

Pieds en caoutchouc

Patas de goma

Gummifüßchen

Piedini di gomma

Pés de borracha

橡胶支脚

Digital Optical Cable

Câble optique numérique

Cable óptico digital

Optisches Digitalkabel

Cavo ottico digitale

Cabo óptico digital

光纖線

BUTTONS

Touches • Botones • Tasten • Pulsanti • Botões • 按钮

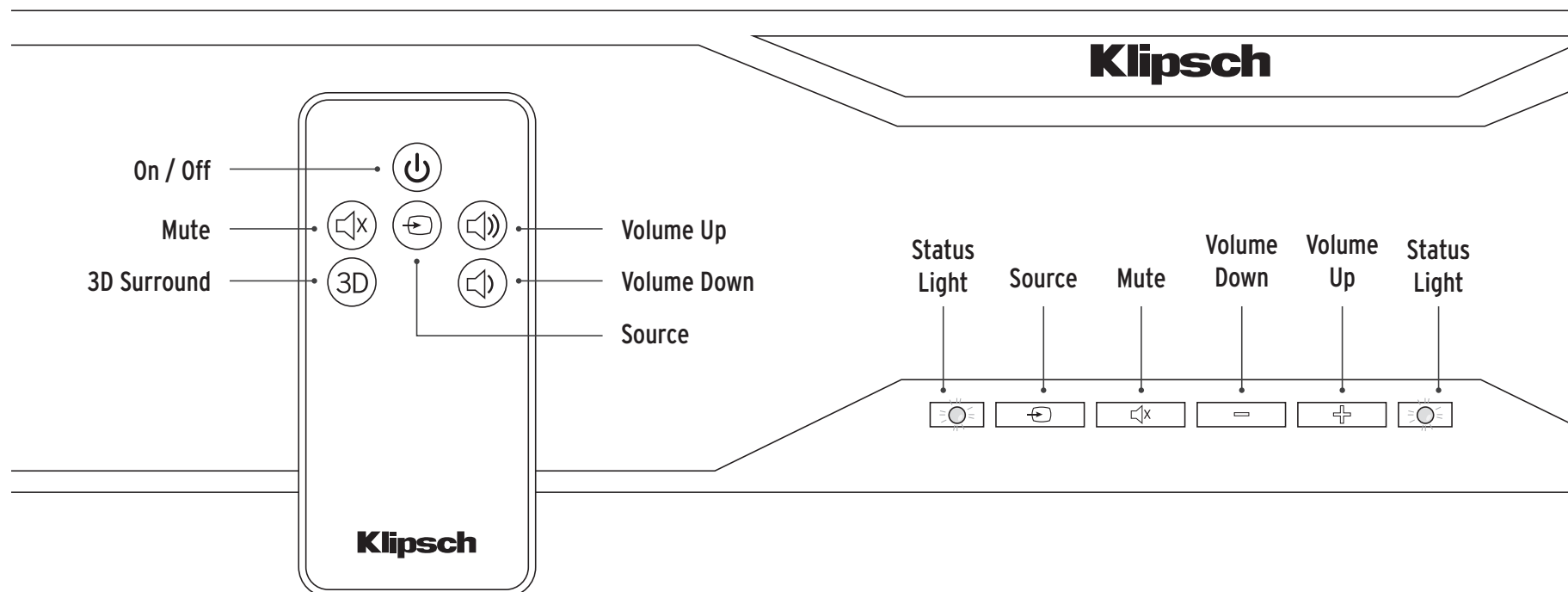

<p>On /Off Sous tensio / Hors tension Encendido / Apagado Ein / Aus Acceso / Spento Ligar / Desligar 开/关</p>	<p>Mute Sourdine Silenciador Stummschaltung Disattivazione audio Desativar áudio 静音</p>	<p>3D Surround Ambiphonie 3D Surround 3D 3D-Surround Surround 3D Surround 3D 3D 环绕</p>	<p>Source Source Fuente Quelle Sorgente Fonte 輸入源的切换</p>	<p>Volume Up Volume haut Subida de volumen Lauter Aumento volume Aumentar o volume 音量增大</p>	<p>Volume Down Volume bas Bajada de volumen Leiser Riduzione volume Diminuir o volume 音量减小</p>
---------------------------------------------------------------------------------------------------------------------------------------------------------------------------------------------------------------	------------------------------------------------------------------------------------------------------------------------------------------------------------------------------------------	-----------------------------------------------------------------------------------------------------------------------------------------------------------------------------------------	-----------------------------------------------------------------------------------------------------------------------------------------------------------	----------------------------------------------------------------------------------------------------------------------------------------------------------------------------------------------	-------------------------------------------------------------------------------------------------------------------------------------------------------------------------------------------------

DIGITAL OPTICAL CONNECTION (PREFERRED - IF TV HAS NO OPTICAL OUT SEE NEXT PAGE)

CONNEXION OPTIQUE NUMÉRIQUE • CONEXIÓN ÓPTICA DIGITAL • OPTISCHE DIGITALVERBINDUNG • CONNESSIONE OTTICA DIGITALE • CONEXÃO ÓTICA DIGITAL • 数字光纤连接

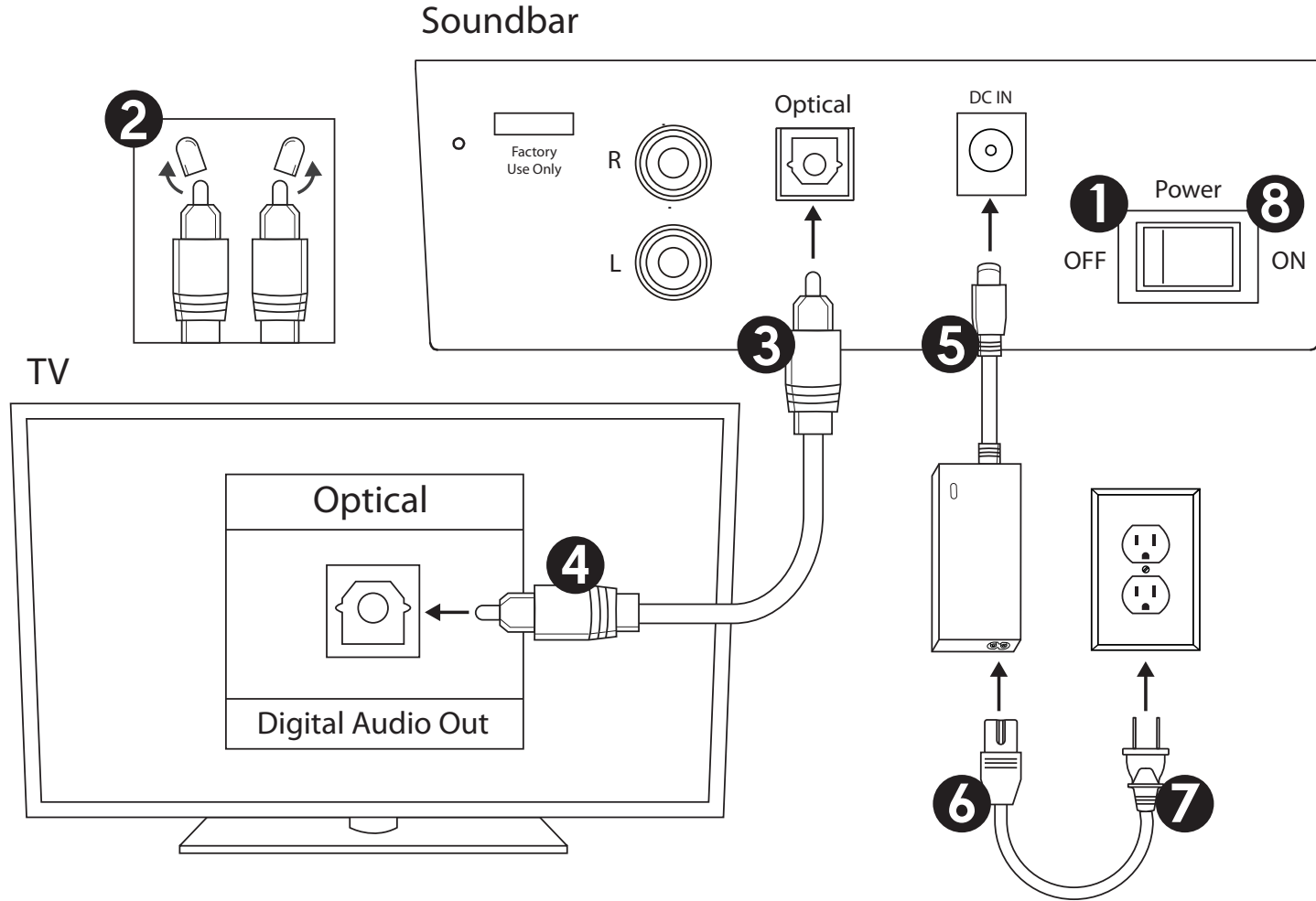

3.5mm TO DUAL RCA ANALOG CONNECTION (IF TV HAS NO HEADPHONE OUT SEE NEXT PAGE)

CONNEXION ANALOGIQUE 3,5 MM VERS DOUBLE FICHE RCA • CONEXIÓN ANALÓGICA RCA DE 3.5 MM A DOS RCA • 3,5 MM ZU DOPPEL-CINCH-ANALOGKABEL • CONNESSIONE ANALOGICA CON JACK DA 3,5 MM A DOPPIO JACK RCA CONEXÃO ANALÓGICA DE 3,5 MM • PARA RCA DUPLO • 3.5MM 转双 RCA 模拟连接

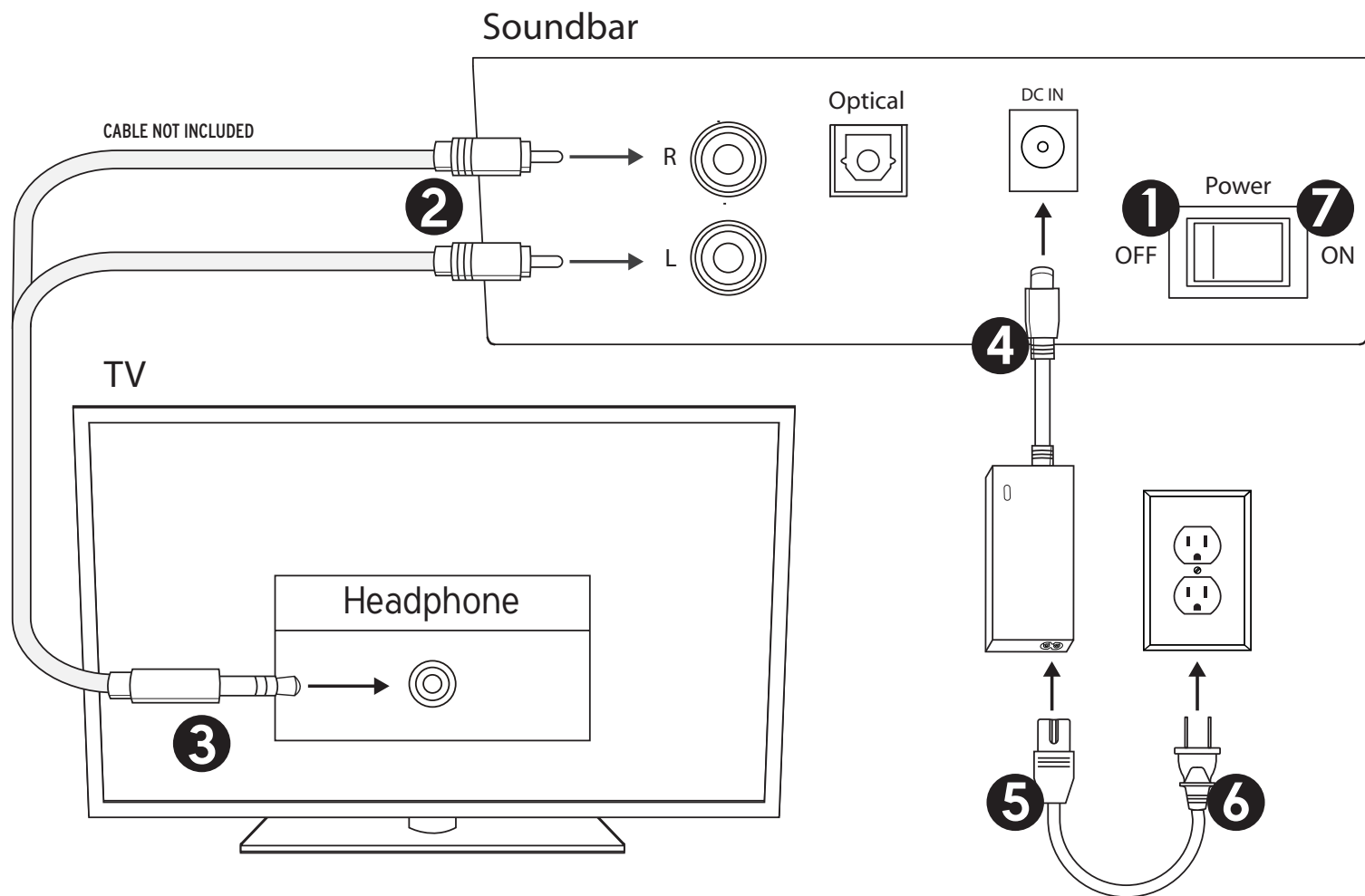

DUAL RCA TO DUAL RCA ANALOG CONNECTION

CONNEXION ANALOGIQUE DOUBLE FICHE RCA VERS DOUBLE FICHE RCA • CONEXIÓN ANALÓGICA DE DOS RCA A DOS RCA • ANALOGVERBINDUNG (DOPPEL-CINCH ZU DOPPEL-CINCH)

CONNESSIONE ANALOGICA DA DOPPIO JACK RCA A DOPPIO JACK RCA • CONEXÃO ANALÓGICA DE RCA DUPLO PARA RCA DUPLO • 双 RCA 转双 RCA 模拟连接

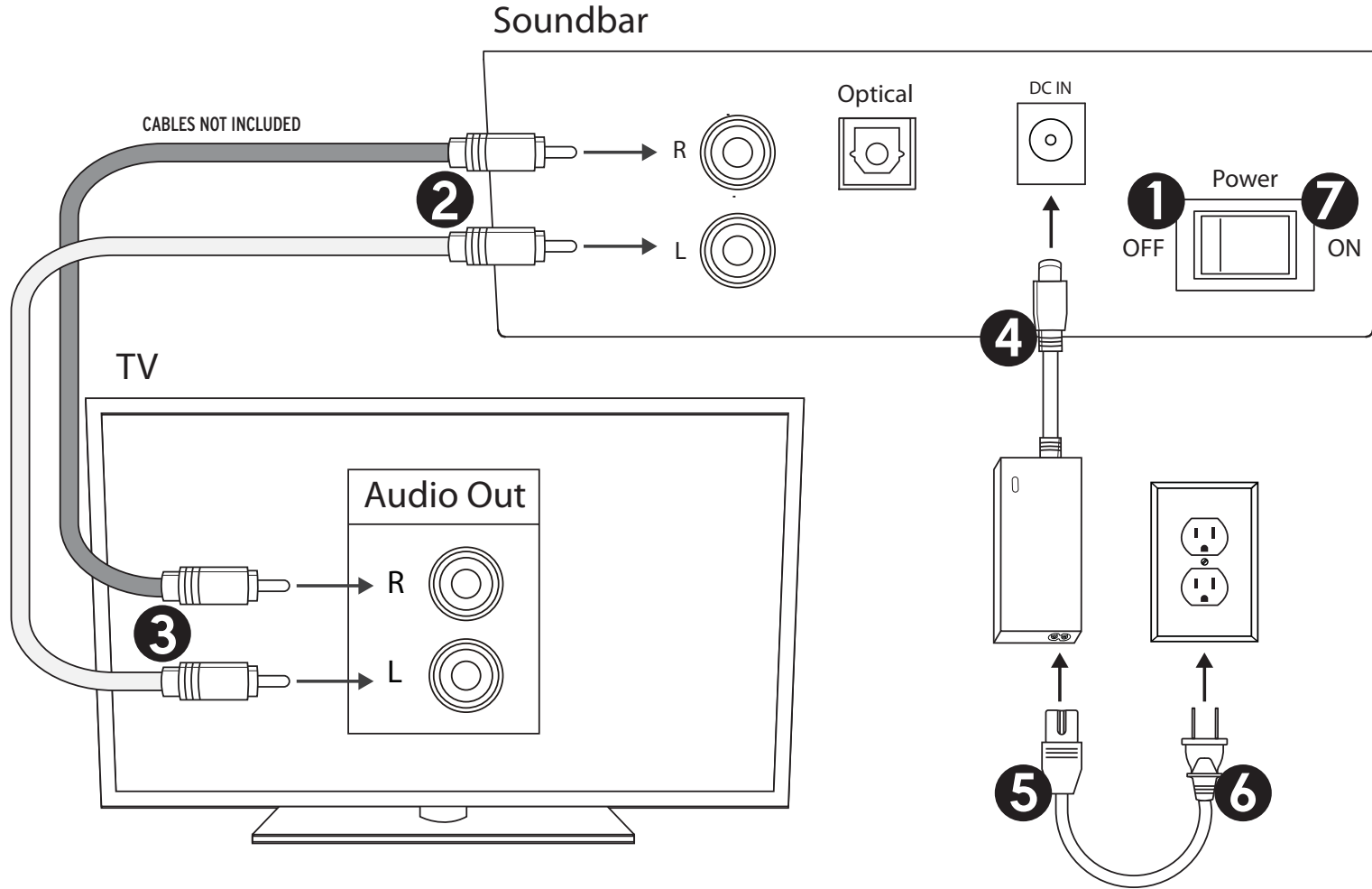

SUBWOOFER WIRELESS CONNECTION

Connexion sans fil du caisson de graves • Conexión inalámbrica del subwoofer • Drahtlose Verbindung zum Subwoofer • Connessione wireless con il subwoofer • Conexão sem fio do subwoofer • 低音炮无线连接

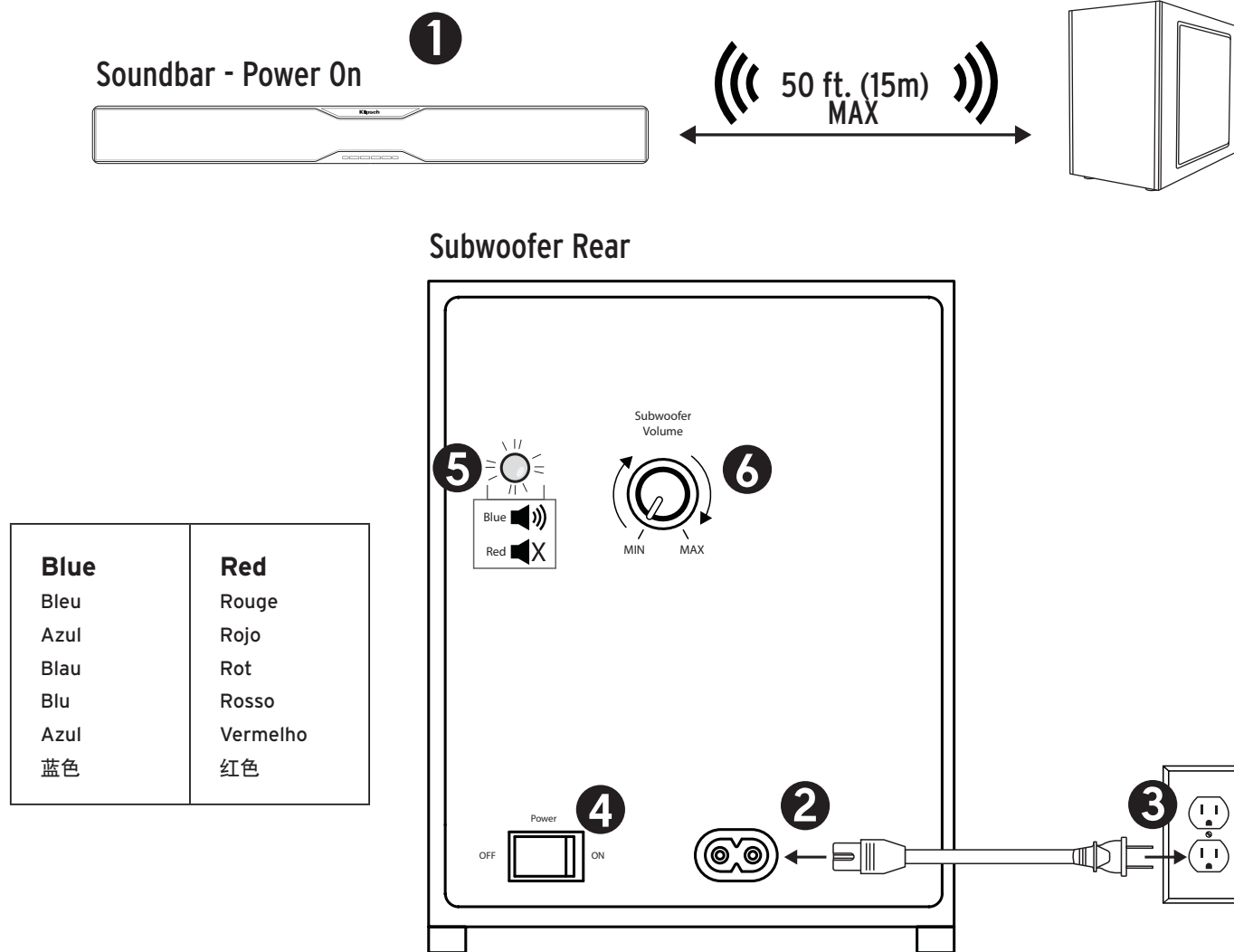

BLUETOOTH® WIRELESS TECHNOLOGY

CONNECT

CONNEXION
CONEXIÓN
VERBINDEN
COLLEGAMENTO
CONECTAR
连接

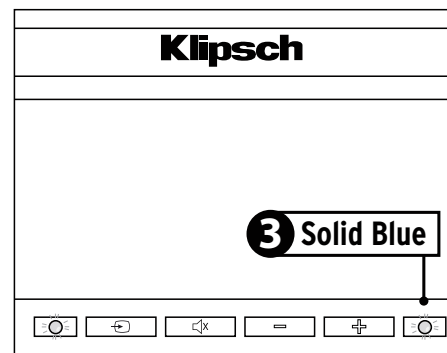
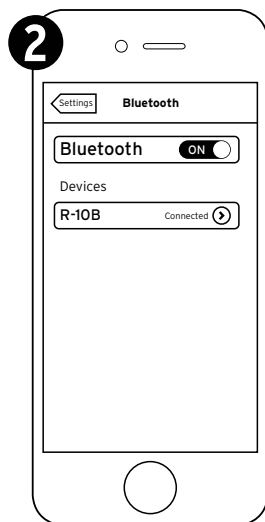
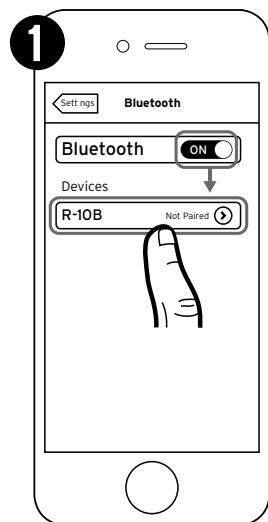

Recommended 30 feet max distance between music source and soundbar for optimum performance.

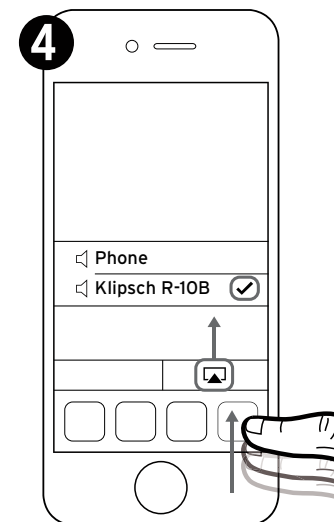

*Example only. Your device may differ. • *À titre d'exemple seulement. Votre appareil peut être différent. • *Este es solo un ejemplo. Es posible que su dispositivo sea diferente. • *Nur als Beispiel. Ihr Gerät kann anders aussehen • *Solo a titolo esemplificativo. Lo specifico dispositivo può essere diverso. • *Apenas para exemplo. O dispositivo pode ser diferente. • *仅为示例。实际设备可能有所不同

DISCONNECT

DÉCONNEXION
DESCONEXIÓN
TRENNEN
SCOLLEGAMENTO
DESCONECTAR
断开连接

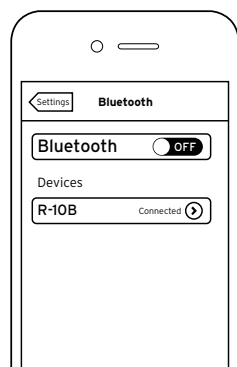

OR

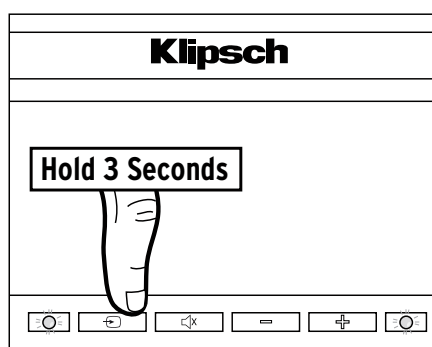

Solid Blue

Bleu continu
Azul continuo
Dauerhaft blau
Blu a luce fissa
Azul constante
纯蓝色

Hold 3 Seconds

Appuyer pendant 3 secondes
Mantenga oprimido durante 3 segundos
3 Sekunden gedrückt halten
Tenere premuto per 3 secondi
Manter pressionado por 3 segundos
保持 3 秒

SOUNDBAR PLACEMENT

POSITIONNEMENT DE LA BARRE DE SON • UBICACIÓN DE LA BARRA DE SONIDO • SOUNDBAR-PLATZIERUNG • COLLOCAZIONE DEL SOUNDBAR • POSIÇÃO DA BARRA SONORA • 条形音箱布置

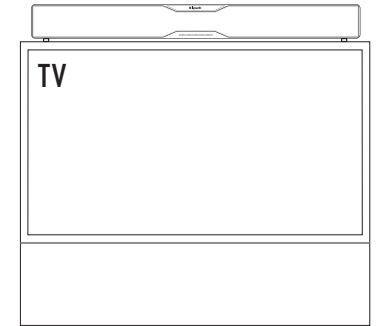
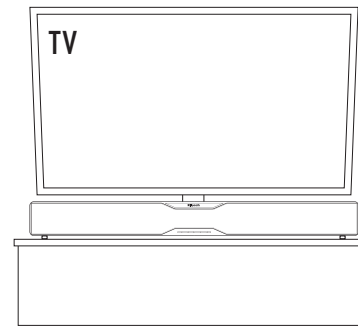
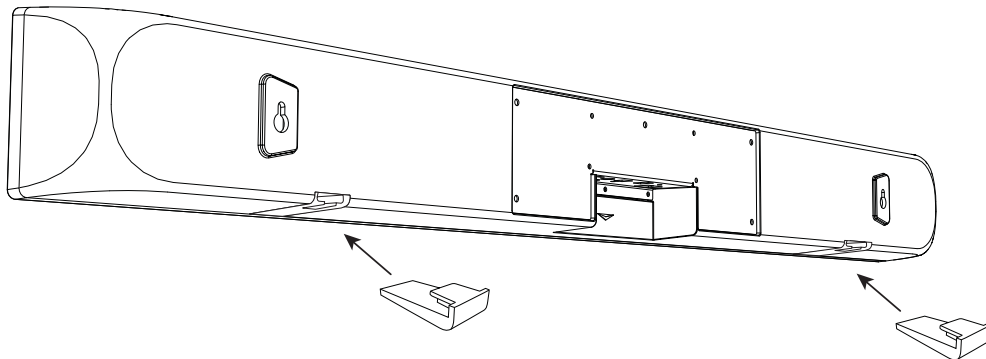
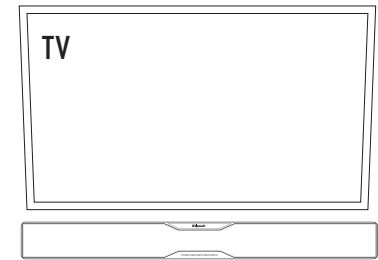
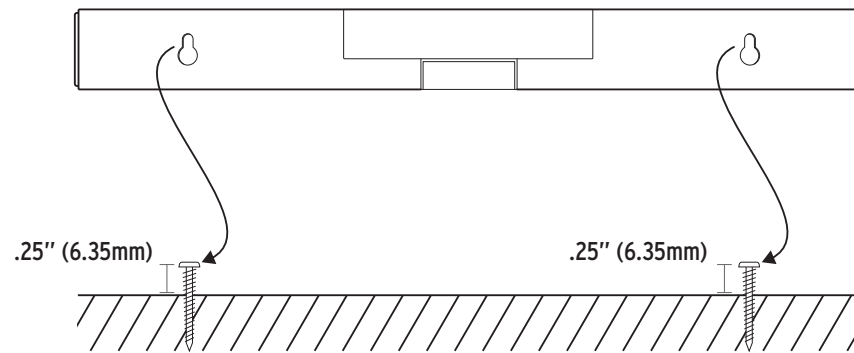
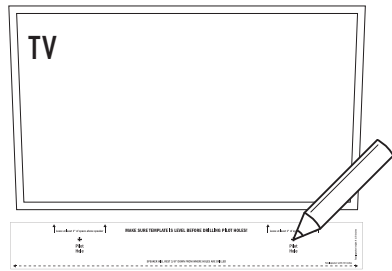

SUBWOOFER PLACEMENT

POSITIONNEMENT DU CAISSON DE GRAVES • UBICACIÓN DEL SUBWOOFER • SUBWOOFER-PLATZIERUNG • COLLOCAZIONE DEL SUBWOOFER • POSIÇÃO DO SUBWOOFER • 低音炮布置

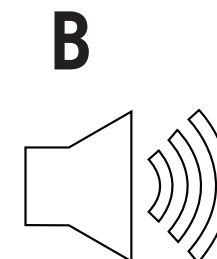
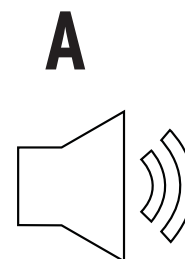
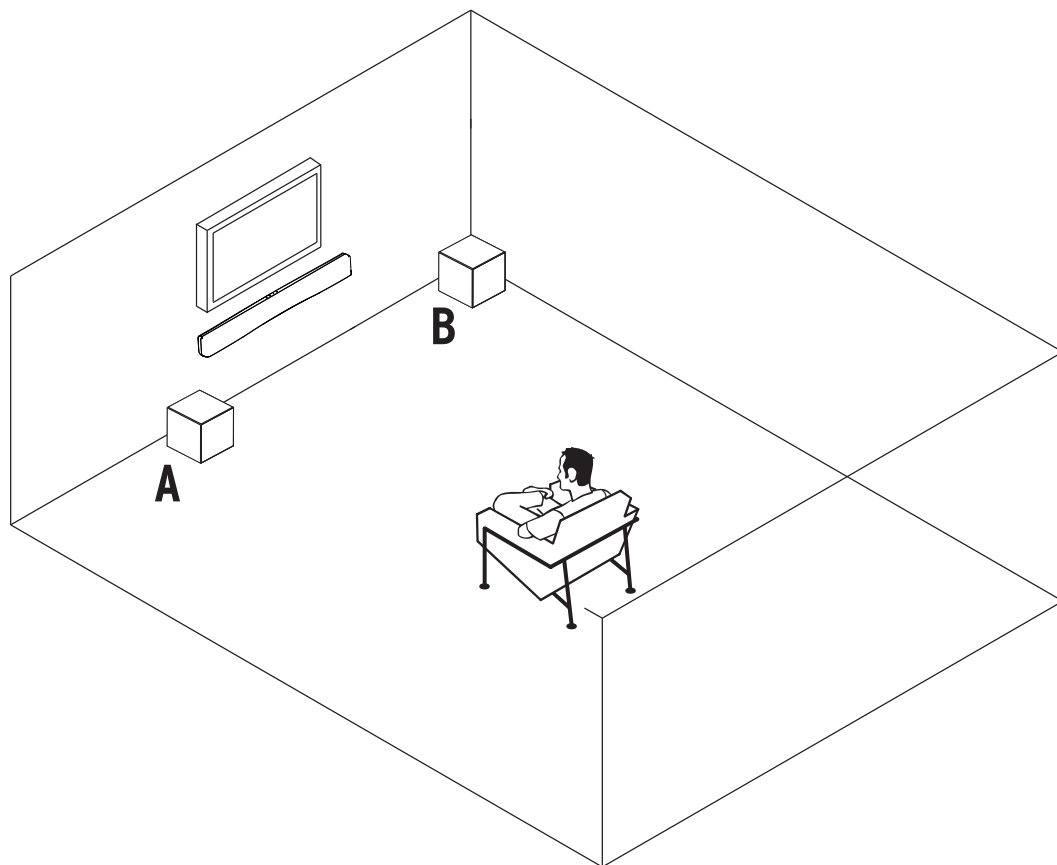

TV REMOTE PROGRAMMING

TV REMOTE PROGRAMMING • PROGRAMMATION À DISTANCE DU TÉLÉVISEUR • PROGRAMACIÓN DEL CONTROL REMOTO DEL TELEVISOR • PROGRAMMIEREN DER TV-FERNBEDIENUNG
PROGRAMMAZIONE CON IL TELECOMANDO TV • PROGRAMAÇÃO DO CONTROLE REMOTO DA TV • 电视机遥控器编程

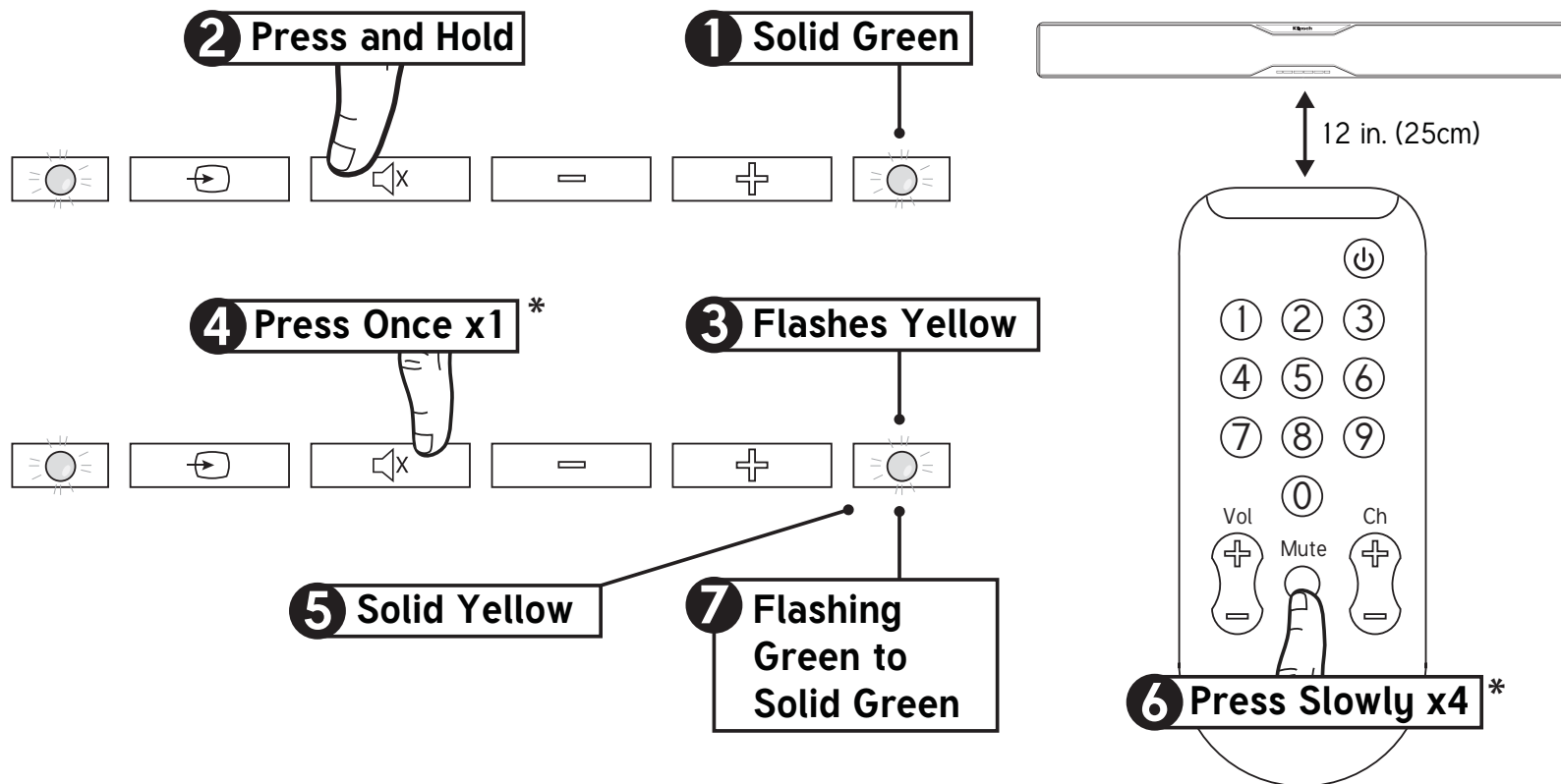

* To program Volume Up and Volume Down buttons repeat the steps shown and replace steps 4 and 6 with the button you want to program.

<p>Press and Hold Appuyer sans relâcher Oprima y mantenga oprimido Gedrückt halten Tenere premuto Pressionar e manter pressionado 按住</p>	<p>Flashes Yellow Clignotement Jaune Destella Amarillo Blinkt Gelb Giallo lampeggiante Amarela intermitente 黄色闪烁</p>	<p>Solid Yellow Jaune continu Amarillo continuo Dauerhaft Gelb Giallo a luce fissa Amarela constante 黄色固体</p>	
<p>Press x1 Appuyer 1 fois Oprima 1 vez 1x drücken Premere 1 volta Pressionar uma vez 按 1 次</p>	<p>Flashing Green Vert clignotant Destello verde Blinkt grün Verde lampeggiante Verde intermitente 绿色闪烁</p>	<p>Solid Green Vert continu Verde continuo Dauerhaft grün Verde a luce fissa Verde constante 纯绿色</p>	<p>Press Slowly x4 Appuyer lentement 4 fois Oprima lentamente 4 veces Langsam 4x drücken Premere lentamente 4 volte Pressionar lentamente 4 vezes 慢按 4 次</p>

To program Volume Up and Volume Down buttons repeat the steps shown and replace steps 4 and 6 with the button you want to program.

Pour programmer les boutons Volume haut et Volume bas, répétez les étapes indiquées et remplacez les étapes 4 et 6 par le bouton que vous voulez programmer.

Para programar los botones de subida y bajada de volumen, repita los pasos indicados poniendo el botón que desea programar en los pasos 4 y 6

Um die Lauter- und Leiser-Tasten zu programmieren, wiederholen Sie die aufgeführten Schritte und wählen in Schritt 4 und 6 die zu programmierende Taste.

Per programmare i pulsanti di Aumento volume e Riduzione volume, ripetere i passaggi illustrati e sostituire i passaggi 4 e 6 con il pulsante che si desidera programmare.

Para programar os botões de aumentar/diminuir o volume, repita os passos indicados e substitua as etapas 4 e 6 com o botão que deseja programar.

要对“调高音量”与“调低音量”按钮进行编程，请重复所示步骤，然后用您想编程的按钮替换第 4 步和第 5 步。

REMOTE CONTROL CODES

RCA*	41609
ONE FOR ALL	1609 OR 0531
DIRECTV	31609 OR 30531
XFINITY**	30531
BRIGHT HOUSE	048
AT&T	5144

*MUST HAVE AUDIO/AUX BUTTON

** RED CENTER BUTTON

HEX CODES - SET 1	
VOLUME UP	0x 856A 9F60
VOLUME DOWN	0x 856A 9E61
MUTE	0x 856A 9966

HEX CODES - SET 2	
VOLUME UP	0x 02A1 DF3B
VOLUME DOWN	0x 02A1 DF3F
MUTE	0x 02A1 DF5F

STATUS LIGHTS

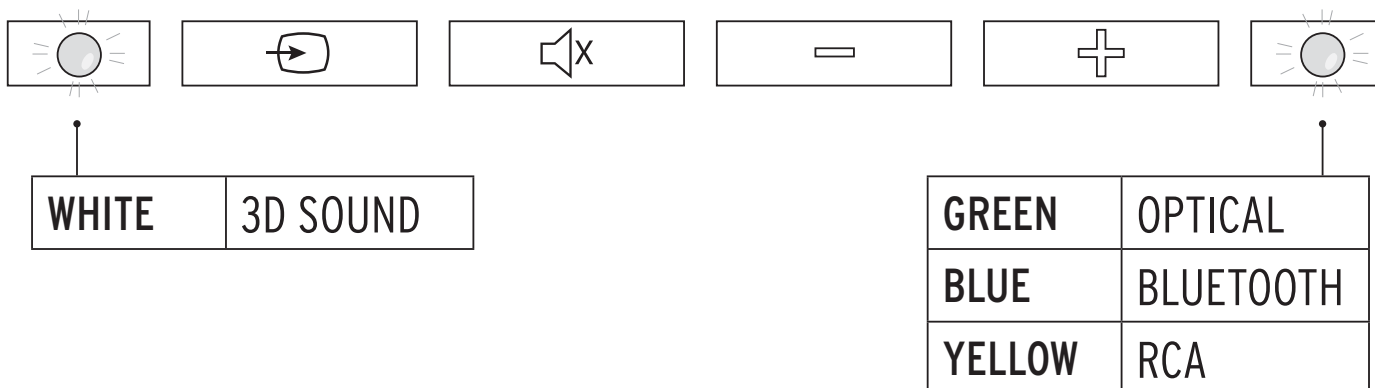

TURN OFF TV SPEAKERS

MISE HORS TENSION DES HAUT-PARLEURS DU TÉLÉVISEUR • APAGADO DE LOS ALTAVOCES DEL TELEVISOR • TV-LAUTSPRECHER DEAKTIVIEREN • SPEGNIMENTO DEGLI ALTOPARLANTI DEL TELEVISORE
DESLIGUE OS ALTO-FALANTES DA TV • 关闭电视机扬声器

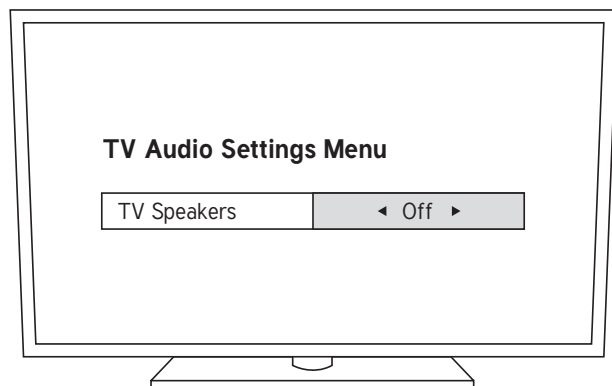

(Recommended)

OR

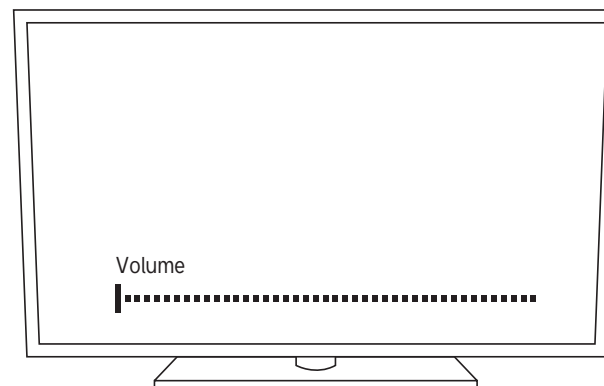

CARE AND CLEANING

ENTRETIEN ET NETTOYAGE • CUIDADO Y LIMPIEZA • PFLEGE UND REINIGUNG • CURA E PULIZIA • CUIDADOS E LIMPEZA • 保养与清洁

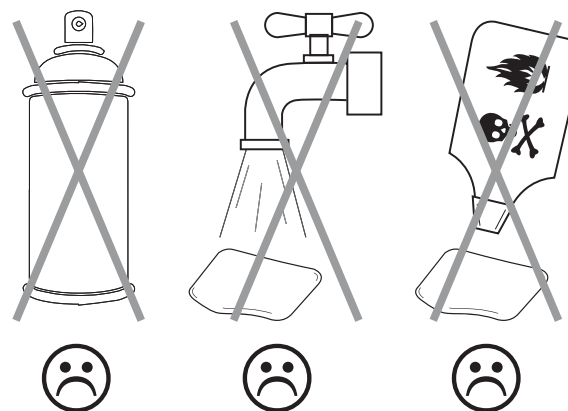
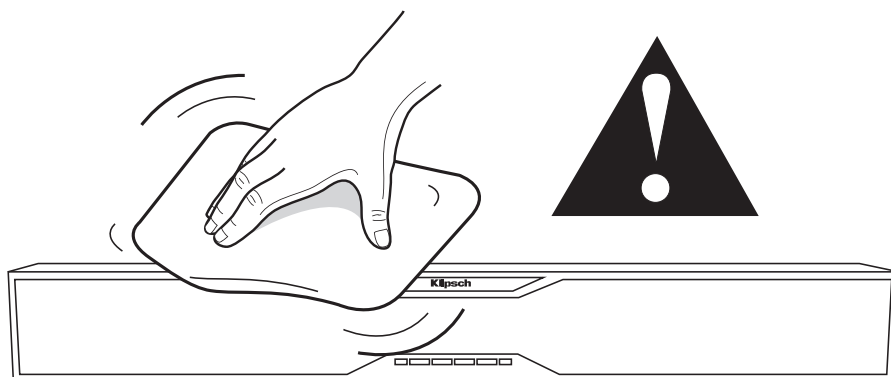

Klipsch[®]

KEEPERS OF THE SOUND[®]

3502 WOODVIEW TRACE, INDIANAPOLIS, IN, USA

KLIPSCH.COM

©2014, Klipsch Group, Inc. Klipsch Group, Inc. is a wholly-owned subsidiary of Vox International Corporation. Klipsch and Keepers of the Sound are trademarks of Klipsch Group, Inc., registered in the United States and other countries. The Bluetooth[®] word mark is a registered trademark owned by Bluetooth SIG, Inc. and any use of such mark by Klipsch Group, Inc. is under license.